

Application Note

Measurement of power conversion efficiency of photovoltaic power generation system

Industry: Renewable & Fossil Energies

Precision Power Analyzer WT5000, WT1800E



Overview

In photovoltaic power generation systems, power conditioning systems (PCSs) and charge-discharge controllers are used to convert direct current output from solar panels into usable alternating current. The parameters that indicate the performance of a power generation system include actual amount of generated power and conversion efficiency.

The conversion efficiency of commercial solar panels ranges from 10% to 20%. Minimizing the loss when converting the solar panel output to AC leads to higher efficiency of the entire power generation system.

In recent years, PCSs for storage batteries and hybrid PCSs that can control storage batteries have also been introduced to the market for residential photovoltaic power generation systems, and a power generation system linked to storage batteries has become the mainstream type.

The conversion efficiency of PCS ranges from 95% to 98%. In order to improve the efficiency by 0.1%, evaluation using a precision power analyzer is required.

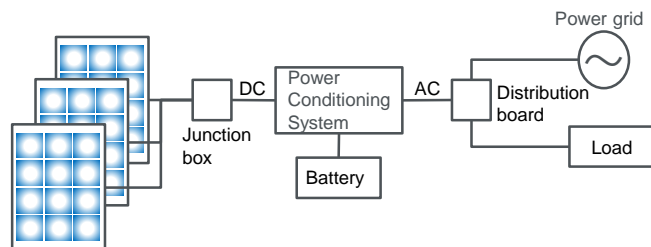

Solar panels

Configuration with a hybrid PCS that controls storage batteries

Challenges / Demands

Measurement methods for conversion efficiency of PCSs are specified in IEC 61683, EN 50530, JIS C 8961 and other standards. Not only the maximum efficiency but also Euro efficiency¹ and CEC efficiency², which are close to the efficiency in actual use conditions, need to be measured. Euro/CEC efficiency is determined from efficiencies at different load levels ranging from light to rated load that are weighted according to the load factor.

Measurement of PCS conversion efficiency

- High-precision measurement of power conversion efficiency from DC and AC voltages/ currents before and after PCS
- Safe and accurate measurement of high voltage and large current

Measurement of MPPT control³

- Accurate measurement of voltage, current and power peak values which are important in MPPT control

Measurement of storage battery charge and discharge

- Charging/Discharging voltage, current, power, integrated current, and power calculation
- Accurate measurement required to achieve higher efficiency
- Checking a number of parameters, including total power over a period of time

Measurement of PCS output power quality

- Voltage and current measurement and power calculation when energy is sold and bought in power grid
- Measurement of power quality (output, frequency, distortion, etc.)

¹ Euro efficiency (Euro-eta, partial load efficiency): Efficiency calculated by weighting conversion efficiencies at different load factors (based on European climate patterns) and adding them together. Euro efficiency is said to a conversion efficiency close to that under actual operating conditions.

² California Energy Commission (CEC) efficiency: Energy efficiency regulations established by the California Energy Commission, USA. Products distributed in California must comply with these regulations.

³ Maximum Power Point Tracking (MPPT) control: A function incorporated in PCSs and other devices to track and control the combination of voltage and current to maximize the PV power at different solar radiation levels. MPPT control is mainly used in large-scale systems.

Solution / Proposal

YOKOGAWA's WT5000 and WT1800E provide optimal measurement solutions for measuring power conversion efficiency of photovoltaic power generation systems.

■ **Simultaneous measurement of power parameters required for efficiency measurement**

Since the WT5000 has a maximum of 7 inputs and the WT1800E has 6 inputs, a single WT5000 or a single WT1800E can measure input/output, voltage, current, power, frequency, and efficiency of a PCS and display the measurements on the screen. The WT5000 and WT1800E can measure not only the maximum conversion efficiency but also Euro efficiency and CEC efficiency.

■ **Trend graph display of power and efficiency**

Fluctuations in power or efficiency are displayed as numerical values or on a trend graph to allow users to understand the fluctuations intuitively.

■ **Large current measurement up to 2000 A**

Use of an optional external current sensor allows measurement of much higher currents up to 2000 A.

■ **IEC harmonic measurement**

Harmonics generated by a PCS can be measured according to IEC standards.

■ **Evaluation of MPPT control**

The voltage peak value, current peak value, and maximum instantaneous power value (+ side, - side, respectively) as well as voltage, current, and power values are useful in evaluating MPPT control.

■ **Evaluation of battery charging/discharging characteristics**

In the evaluation of battery charging/discharging characteristics, the integration function is used to calculate each power amount from the instantaneous positive and negative power values.

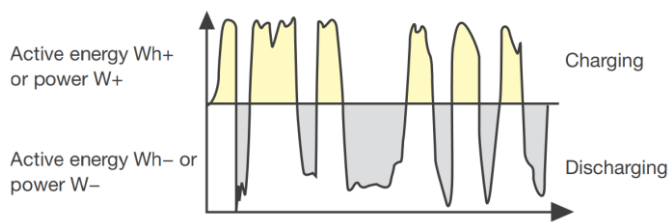

WT5000 example of numeric display

Urms1/Irms1/P1 : Solar cell module output

Urms2/Irms2/P2 : Boost converter output

Urms3/Irms3/P3/λ3/fU3/Idc3/Uthd3

: Inverter output and power quality

η1 : Boost converter efficiency

η2 : Inverter efficiency

η3 : Overall PCS efficiency

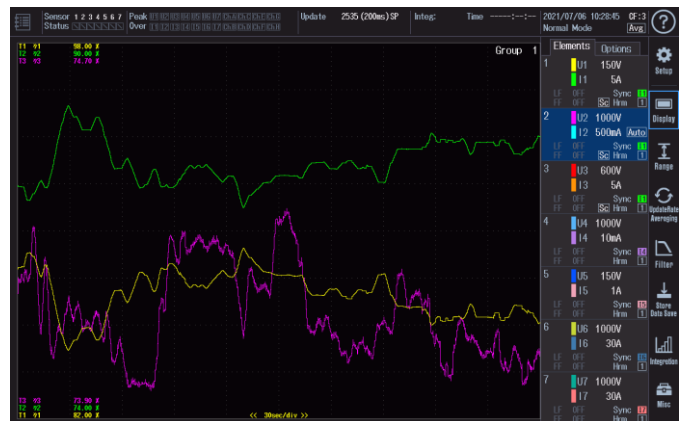

WT5000 example of trend display of efficiency η1/η2/η3

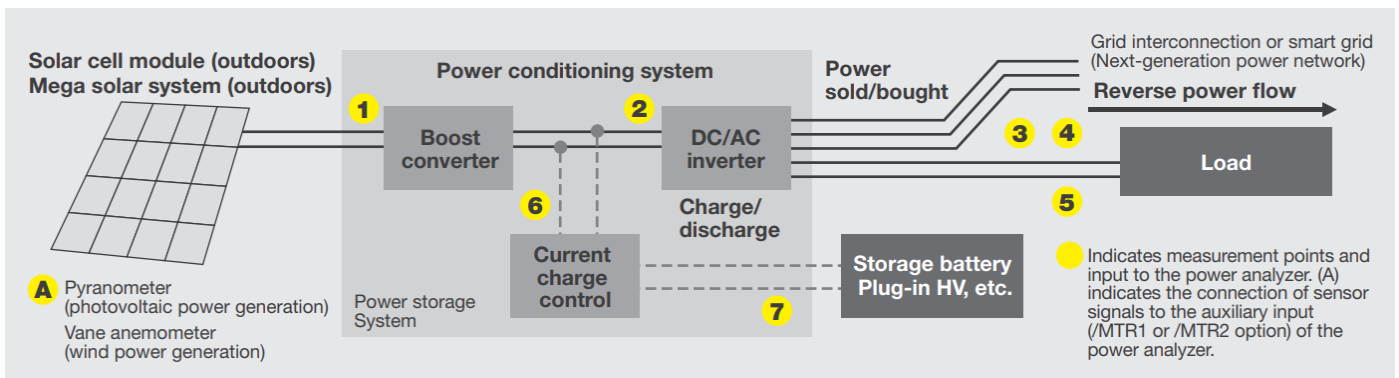

WT5000 simultaneous measurement of seven channels

■ **Display of input signal waveform**

Waveforms of input signals can be displayed without using an oscilloscope, and advanced settings, such as filter setting, can be made while checking the actual input signal.

In addition, the WT5000 Data Streaming (/DS option) allows you to continuously stream waveform data synchronized with power parameter measurements to a PC at up to 2 MS/s without any gaps. Power parameter measurements and voltage/current waveform data of the same measurement period based on which the power calculations are made can be synchronized and streamed. You can check noise on waveforms or a change in control state and can perform a detailed analysis to see how the noise or the change affects the power value and parameters.

■ **To measure large currents with high accuracy**

A current sensor has a through type structure, and the current flowing through the primary wiring is detected by the winding of the electromagnetic core of the current sensor. It is necessary to pay attention to the following points.

1. Choose a current sensor with appropriate rated current and frequency bandwidth
2. Wiring Considerations
 - Place the primary wiring in the center of the current sensor.
 - Ensure the primary wiring and secondary wiring do not interfere with each other. Make the secondary wiring as short as possible and maintain its distance from the primary wiring, without allowing them to be parallel to each other.
 - AWG24 or higher is recommended for the secondary wiring material. Twisted-pair may be more suitable than shielded cable for inverter measurements.

3. Use the amplitude/phase correction function

When an AC/DC current sensor or current clamp probe is used, its amplitude error and the phase difference between the voltage and current signals can be corrected to enable more accurate power measurement.

4. Use individual Null to remove offsets

Null is a function that resets the offset value to zero while wired, including an external current sensor. Null can be individually set to ON, HOLD, or OFF for each input. It is recommended that you execute zero-level compensation (a function to compensate for the zero level in the internal circuit) before enabling the null function.

Simple wiring for high-current equipment measurement

The WT5000's 760903 current sensor element is an input element dedicated for connection to an AC/DC current sensor or current clamp probe required for measurement of high-current equipment. With this current sensor element equipped with a DC power supply for sensors, an external DC power supply and time-consuming wiring preparation are no longer required, and you just need a single WT5000 and sensor/probe for large current measurements.

Combined with the /PD2 option (current sensor power), a dedicated cable, shunt resistor box, and sensor, a WT1800E can measure high currents.



WTViewerE application software

- Connection, control, and synchronization of up to four power analyzers
- Computation between power analyzers based on measurement data from them
- Offline analysis of measurement data
- Saving measurement data (Numeric, Waveform) in binary format and CSV format
- Data streaming to allow waveform acquisition at up to 2 MS/s & synchronous measurement of waveforms and power parameters (WT5000 /DS option required)

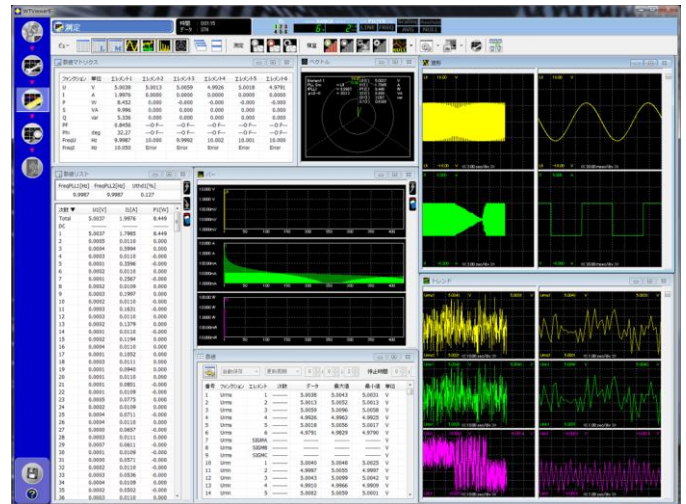

Example of measurement screen

Integrated Software Platform IS8000

- Synchronous measurement with ScopeCorder DL950, Precision Power Analyzer WT5000, third-party high-speed cameras, and other instruments
- Remote control via USB/Ethernet
- Waveform math and comparative analysis
- IEC harmonic/flicker measurement (IS8011/IS8012)
- Save in MDF format
- Automatic reporting





Synchronous display of DL950 waveform data and WT5000 power data

AC/DC Current Sensors

Choose a model based on the AC/DC current to be measured and the measurement bandwidth.



WT series Line-up

Major Specifications	 WT5000	 WT1800E /PD2 option
Number of input channels	1 to 7 (Modular)	1, 2, 3, 4, 5, 6
Basic Power Accuracy	±(0.01% of reading + 0.02% of range)	±(0.05% of reading + 0.05% of range)
DC Power Accuracy	±(0.02% of reading + 0.05% of range)	±(0.05% of reading + 0.05% of range)
A/D Converter	18-bit, 10 MS/s	16-bit, 2 MS/s
Continuous maximum allowable input	Peak voltage of 1.6 kV or RMS of 1.5 kV whichever is lower	Peak voltage of 1.6 kV or RMS of 1.5 kV whichever is lower
Measurements	U, I, P, S, Q, Power Factor, Efficiency, Phase, Upk, Ipk, f, Wp, q, CF, FF, Impedance, Rs, Rp, Xs, Xp, Pc, Harmonic Distortion	U, I, P, S, Q, Power Factor, Efficiency, Phase, Upk, Ipk, f, Wp, q, CF, FF, Impedance, Rs, Rp, Xs, Xp, Pc, Harmonic Distortion

• Cables and terminals for measurements of high voltage such as 1500Vdc need to be prepared by the user.



<https://tmi.yokogawa.com/>

YMI-KS-MI-SE08

YOKOGAWA TEST & MEASUREMENT CORPORATION

Global Sales Dept. /Phone: +81-42-690-8810 E-mail: tm@cs.jp.yokogawa.com
Facsimile: +81-42-690-8826

The contents are as of October 2021. Subject to change without notice.
Copyright © 2021, Yokogawa Test & Measurement Corporation

[Ed:01/d]
Printed in Japan, 110(YMI)

YOKOGAWA CORPORATION OF AMERICA

YOKOGAWA EUROPE B.V.

YOKOGAWA TEST & MEASUREMENT (SHANGHAI) CO., LTD.

YOKOGAWA ELECTRIC KOREA CO., LTD.

YOKOGAWA ENGINEERING ASIA PTE. LTD.

YOKOGAWA INDIA LTD.

YOKOGAWA ELECTRIC CIS LTD.

YOKOGAWA AMERICA DO SUL LTDA.

YOKOGAWA MIDDLE EAST & AFRICA B.S.C(c)

Phone: +1-800-888-6400

Phone: +31-88-4641429

Phone: +86-21-6239-6363

Phone: +82-2-2628-3810

Phone: +65-6241-9933

Phone: +91-80-4158-6396

Phone: +7-495-737-7868

Phone: +55-11-3513-1300

Phone: +973-17-358100

E-mail: tmi@us.yokogawa.com

E-mail: tmi@nl.yokogawa.com

E-mail: tmi@cs.cn.yokogawa.com

E-mail: TMI@kr.yokogawa.com

E-mail: TMI@sg.yokogawa.com

E-mail: tmi@in.yokogawa.com

E-mail: info@ru.yokogawa.com

E-mail: eproc@br.yokogawa.com

E-mail: help.ymatmi@bh.yokogawa.com

Facsimile: +86-21-6880-4987

Facsimile: +82-2-2628-3899

Facsimile: +65-6241-9919

Facsimile: +91-80-2852-1442

Facsimile: +7-495-737-7869

Facsimile: +973-17-336100